

Your resource for happenings at the Ventura County Library

Ventura
County

READER

Explore, Discover, & Connect

Spring 2024

IN THIS ISSUE

Rising from the Ashes Save the Date • 3

Spring Events for Kids • 4

Heritage Month Reads • 5-6, 9-11

Curated Reads • 7-8, 12-17

Color & Cut: Jeepney & Tuk Tuk • 18-19





LIBRARY UPDATE

NANCY SCHRAM
VENTURA COUNTY LIBRARY DIRECTOR
CONTACT INFO: (805) 256-8535
NANCY.SCHRAM@VENTURA.ORG

As an Agency of the County of Ventura, the Ventura County Library and the public we serve have tremendously benefitted from excellent leadership at the county level. I'm also very proud of the amazing employees at the Ventura County Library (VCL), and the many accomplishments at VCL since 2017.

These achievements include a newly expanded and renovated Fillmore Library that reopened to the public in November 2022, a \$1.54 million Building Forward grant from the state for the Ray D. Prueter Library in Port Hueneme, an \$8.7 million Building Forward grant for the EP Foster Library in Ventura, a \$980,000 Building Forward grant for the Meiners Oaks Library, the opening of a new library on the east side of Ventura (Hill Road Library) in 2017, the purchase and implementation of a new Mobile Library in 2019 through a \$100,000 grant from the state and match from the Ventura County Library Foundation, multiple programs implemented through grants funds received including Lunch at the Library, Career Online High School and READ Adult Literacy, and many community partnerships established to implement dynamic and relevant public services such as Parent and Child Together classes in partnership with First 5 Ventura County and the School Mobile Library with Ventura County Office of Education.





VENTURA COUNTY LIBRARY FOUNDATION
Presents

RISING FROM THE ASHES HOME TOUR



*Artwork by
Susan Cook*

DON'T MISS OUT!

SAVE THE DATE

Saturday, April 20, 2024 | 12PM - 4PM | Ventura, CA

Limited Tickets Go On Sale March 1, 2024

www.vclibraryfoundation.org

Tickets \$50

SPRING EVENTS

Play to Learn

Drop-in play group for caregivers and kids aged 0- 5 years.
Oak View Library in the Community Room
Tuesdays, 3:30pm, following the weekly 3pm storytime

These 30 minute sessions feature sensory, art, and perceptual/motor development activities. A great opportunity for social-emotional learning, and to practice school readiness skills!



Game on! Tabletop Games

11:00am - 1:00pm Saturdays at Oak View & 11:00am - 1:00pm Sundays at Hill Rd.

Drop by and choose from many types of games to play!
For all ages.
Fun for families or a great reason to meet with friends.



Ventura County Library

MINECRAFT

Servers for kids and teens

Join us for gaming at the library!

Kids aged 5-17, first come first served.

E.P. Foster & Hill Rd. Libraries



Mondays 3:30 - 5:00pm



In-Person & Virtual Storytime

Check our website for dates and times.

Past episodes available on



BLACK HISTORY MONTH

FEBRUARY 2024

This list of reads features more than one trailblazer. Find out about an Oscar-winning fashion designer, a former slave leading others north, a friend of First Lady Eleanor Roosevelt, and more.



Fiction

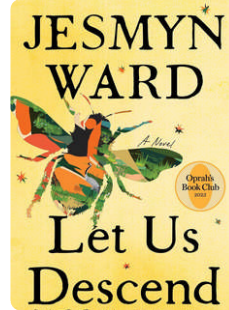
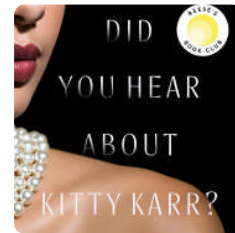
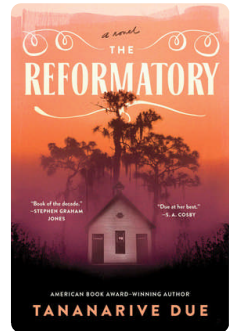
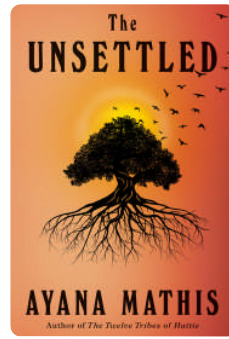
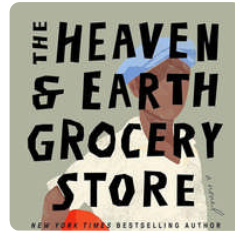

Nonfiction

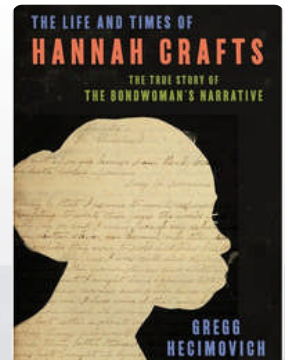
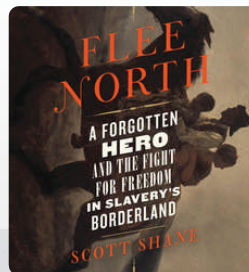
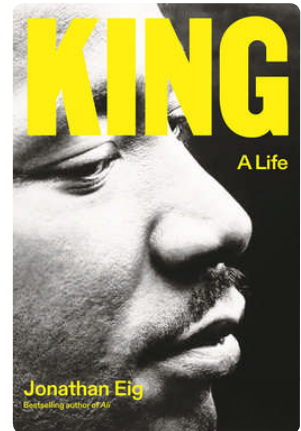
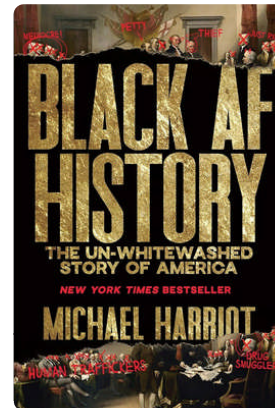
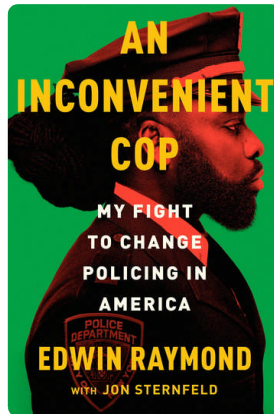

BLACK HISTORY MONTH

Youth



Children's
Picturebooks

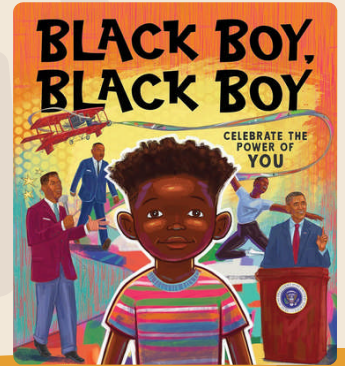
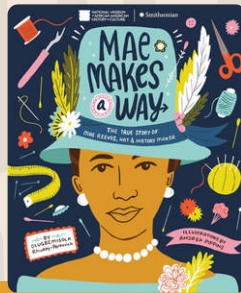
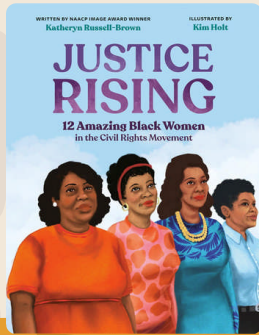
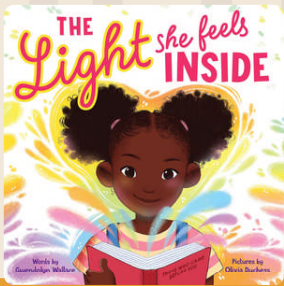

Children's
Fiction &
Nonfiction

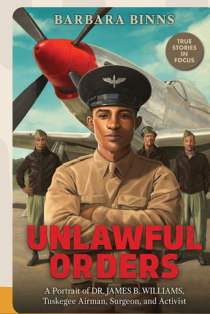
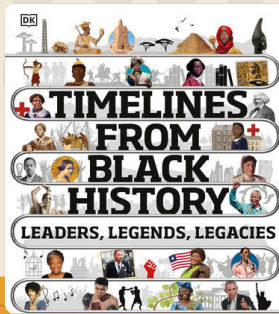
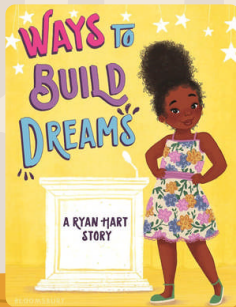
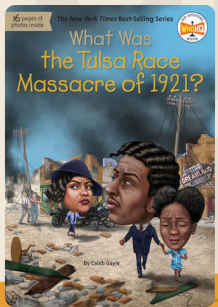

Young
Adult

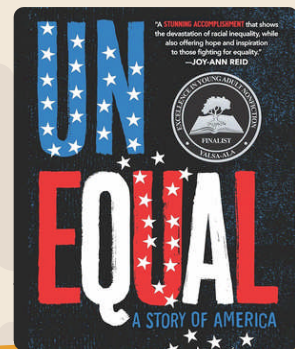
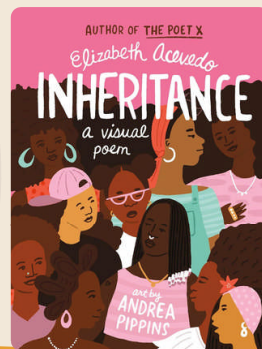
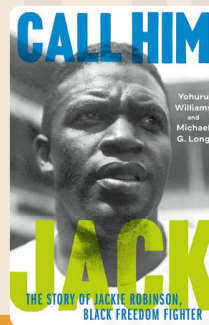
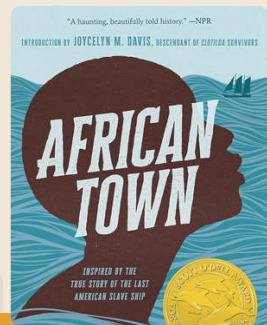
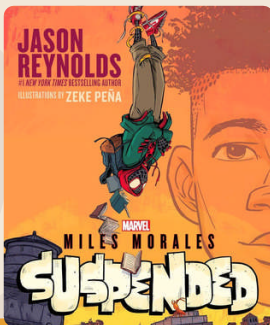

WOMEN'S HISTORY MONTH

March is Women's History Month. Control over the self and your destiny fuels both the nonfiction issues and fictional desires of the women portrayed here.

Fiction

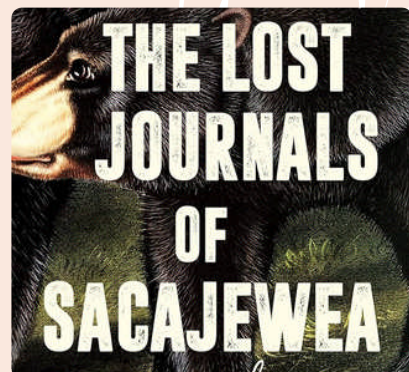
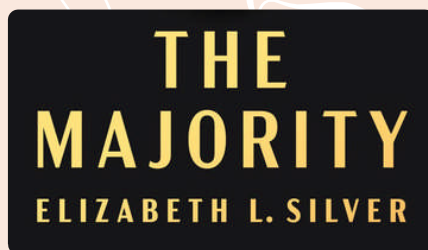

Nonfiction

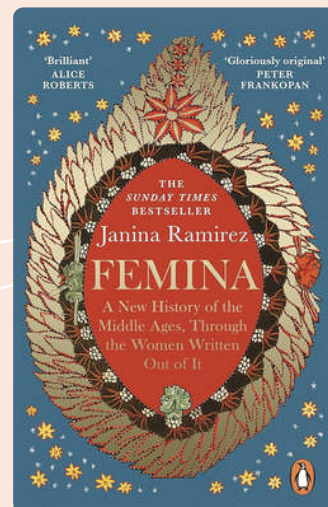
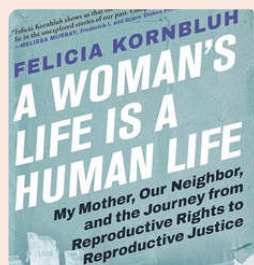
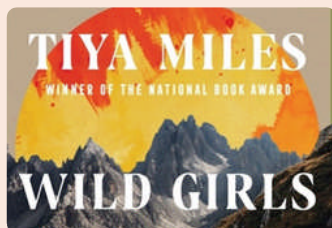
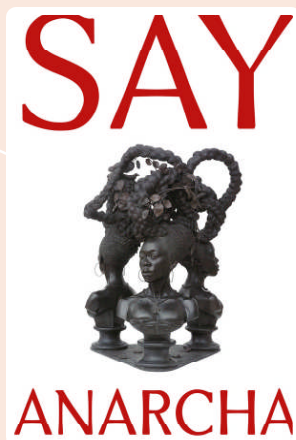

WOMEN'S HISTORY MONTH

HONORING THE CONTRIBUTIONS OF WOMEN



Children's Picturebooks

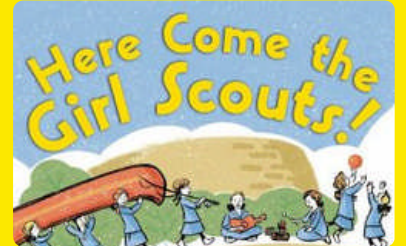

Middle Grade

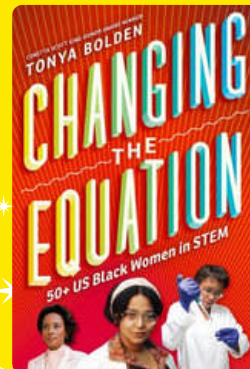
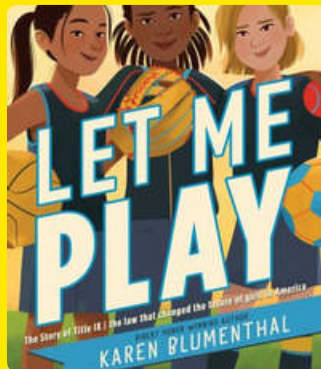

Teen

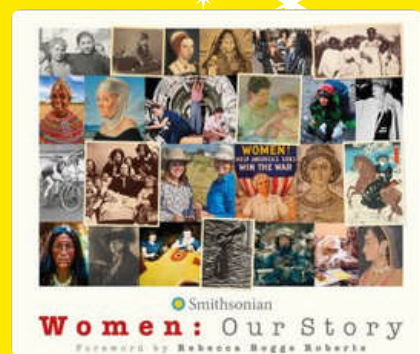
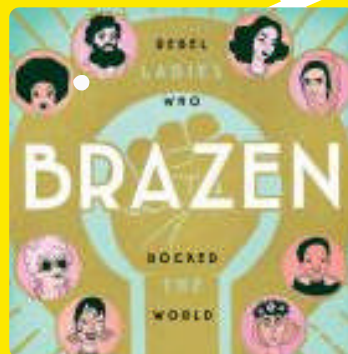
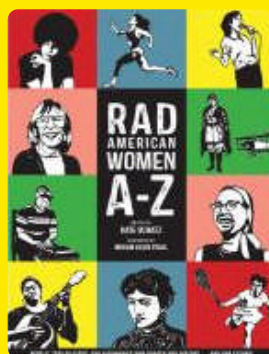
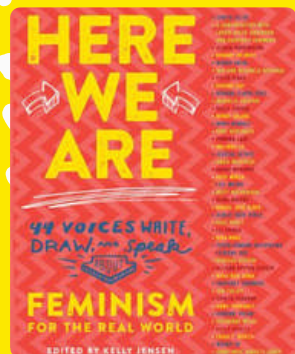

ASIAN/PACIFIC AMERICAN Heritage Month

May 2024

There's a large area to cover here - from Japan and Iran to India and Hawaii. Our fiction selections honoring Asian/Pacific Americans deal with characters confronting their heritage. For more Own Voices suggestions, try [Novelist Plus](#) in our eLibrary.

Nonfiction

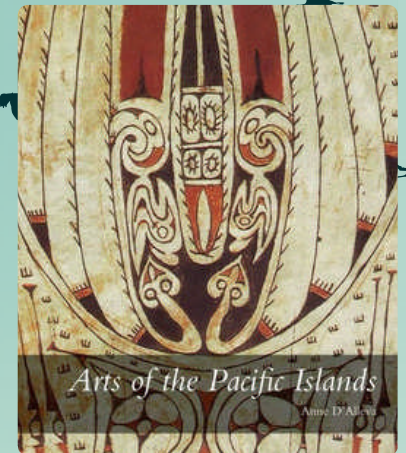
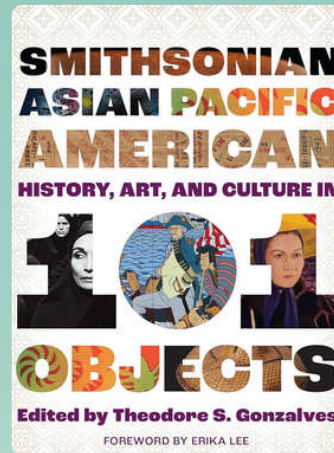
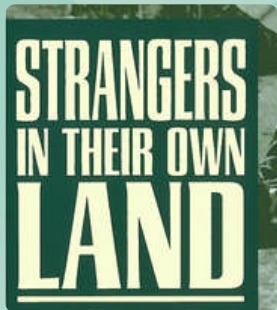

Young Adult Fiction



ASIAN/PACIFIC AMERICAN Heritage Month

May 2024

Children's Picturebooks

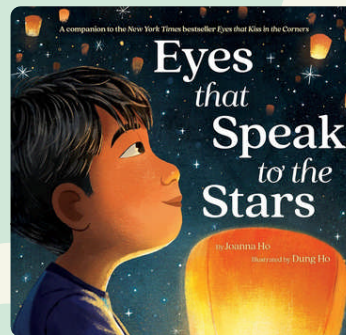
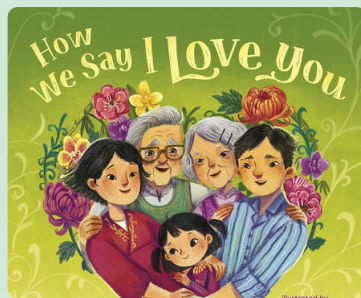
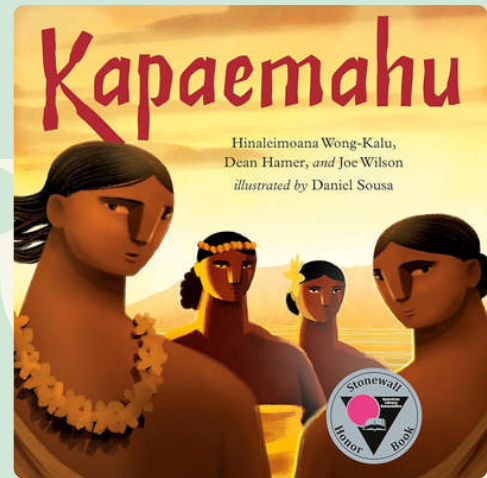
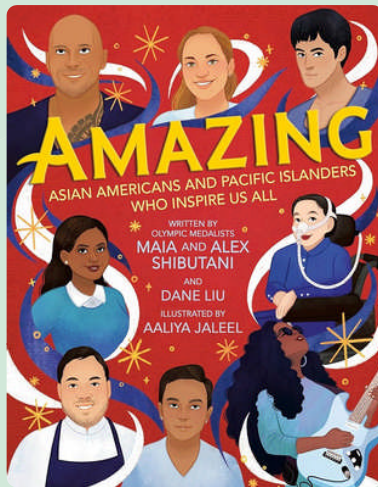
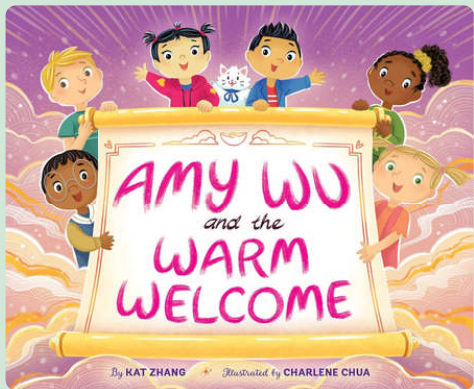

Children's Fiction & Nonfiction

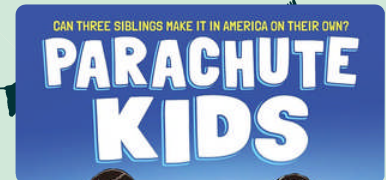
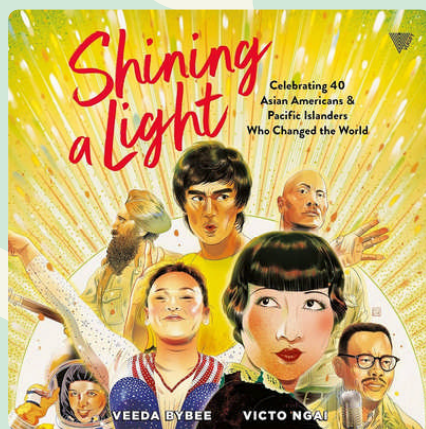
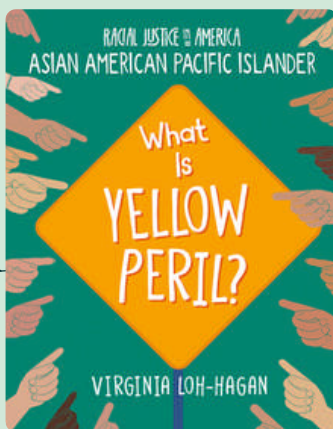

Hawaii

Hawaii is a state of dreams and legends, unique culture, and beautiful customs. The fiction and nonfiction we've picked reveal the many facets of the islands.

Fiction

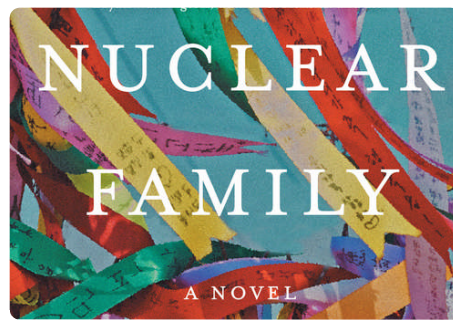
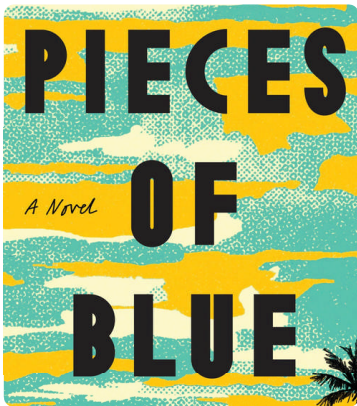
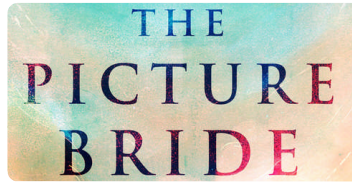
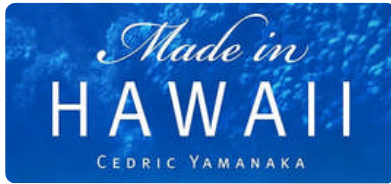

COOK REAL HAWAII



Nonfiction

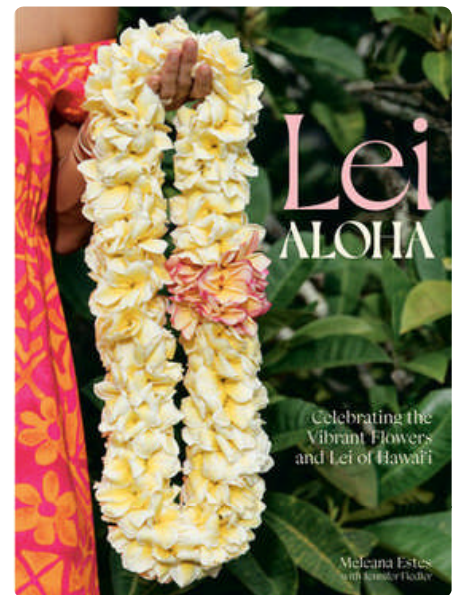
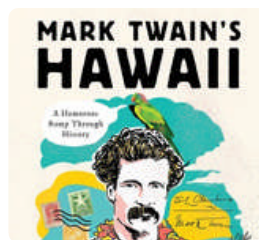
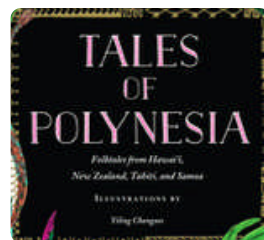
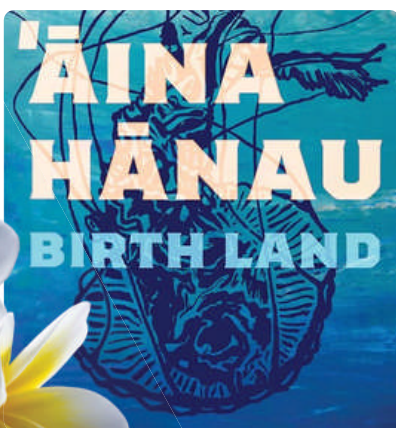

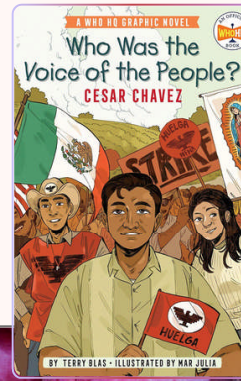
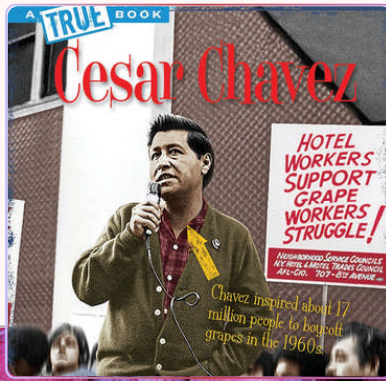
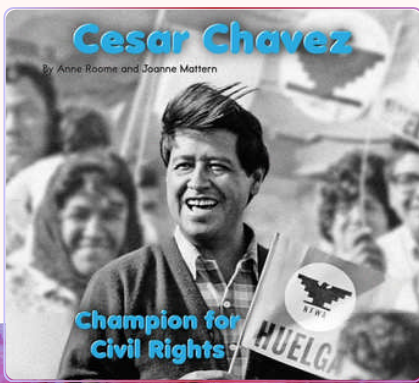

CESAR CHAVEZ & DOLORES HUERTA



Cesar Chávez and Dolores Huerta were integral in changing the lives of migrant farmworkers in California. Chávez and Huerta worked together to create the National Farm Workers Association which dramatically changed the lives of migrant workers. Farm workers organized to receive higher wages, help with rents and improve living spaces in migrant worker camps. Find a book in the VCL collection and learn more about the joint efforts of Chávez and Huerta and how they changed history right here in California.

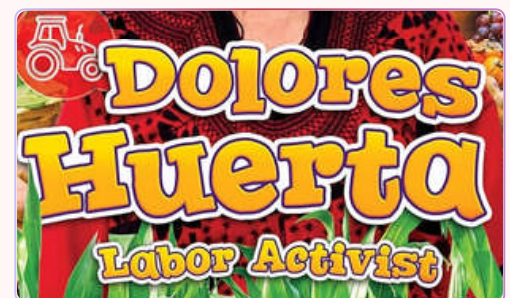
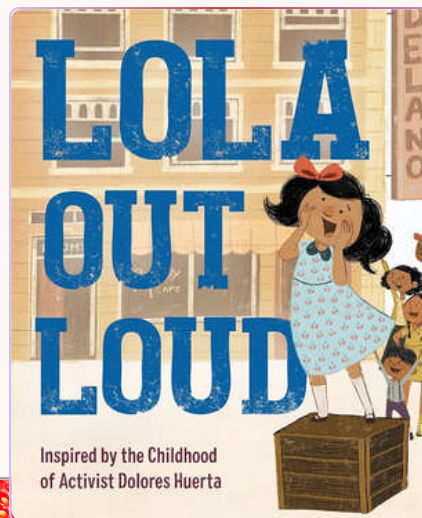
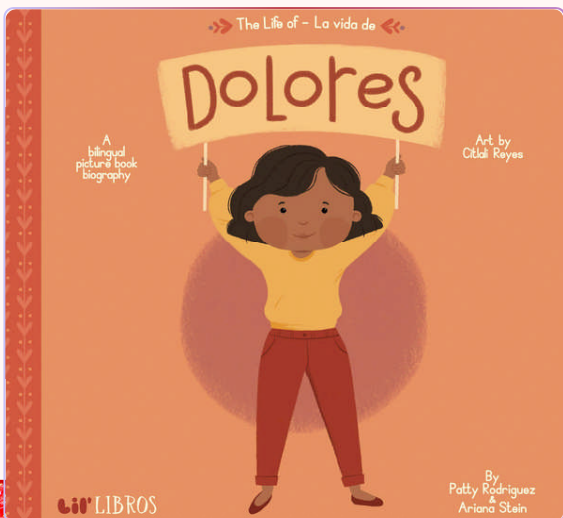
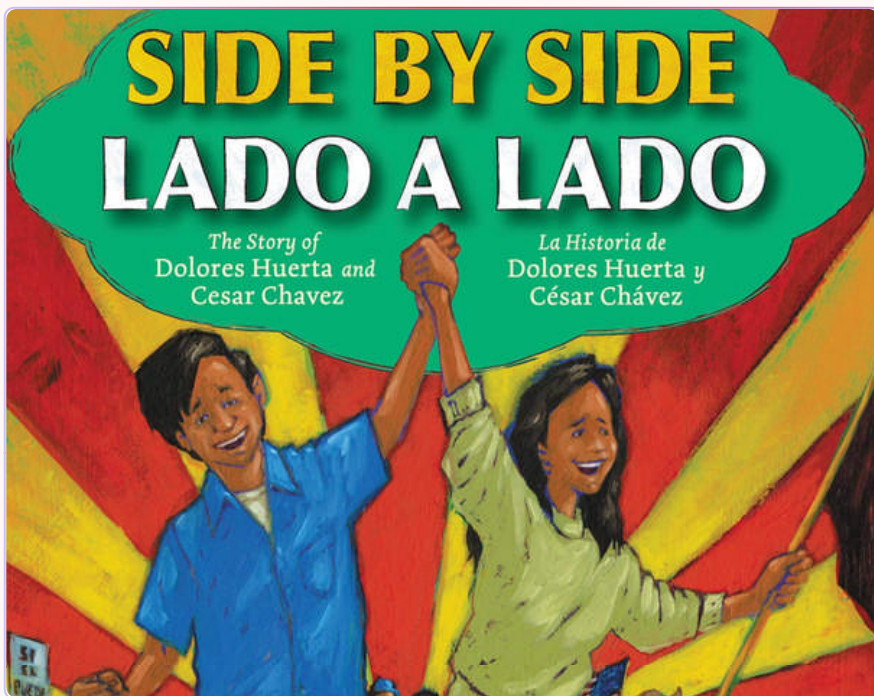



El día de los niños/El día de los libros (Children's Day/Book Day), commonly known as Día, is a celebration every day of children, families, and reading that culminates yearly on April 30.

Día is a nationally recognized initiative that emphasizes the importance of literacy for all children of all linguistic and cultural backgrounds. It is a daily commitment to linking children and their families to diverse books, languages, and cultures.

American Library Association

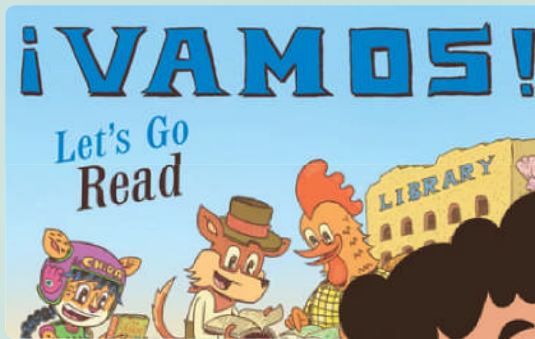
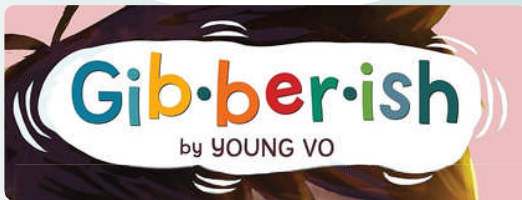
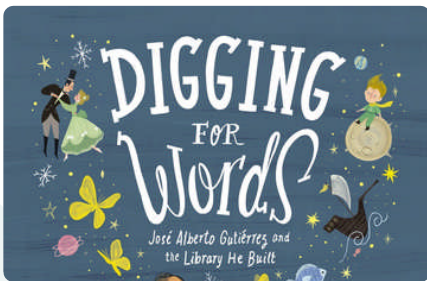

MENTAL HEALTH

Awareness

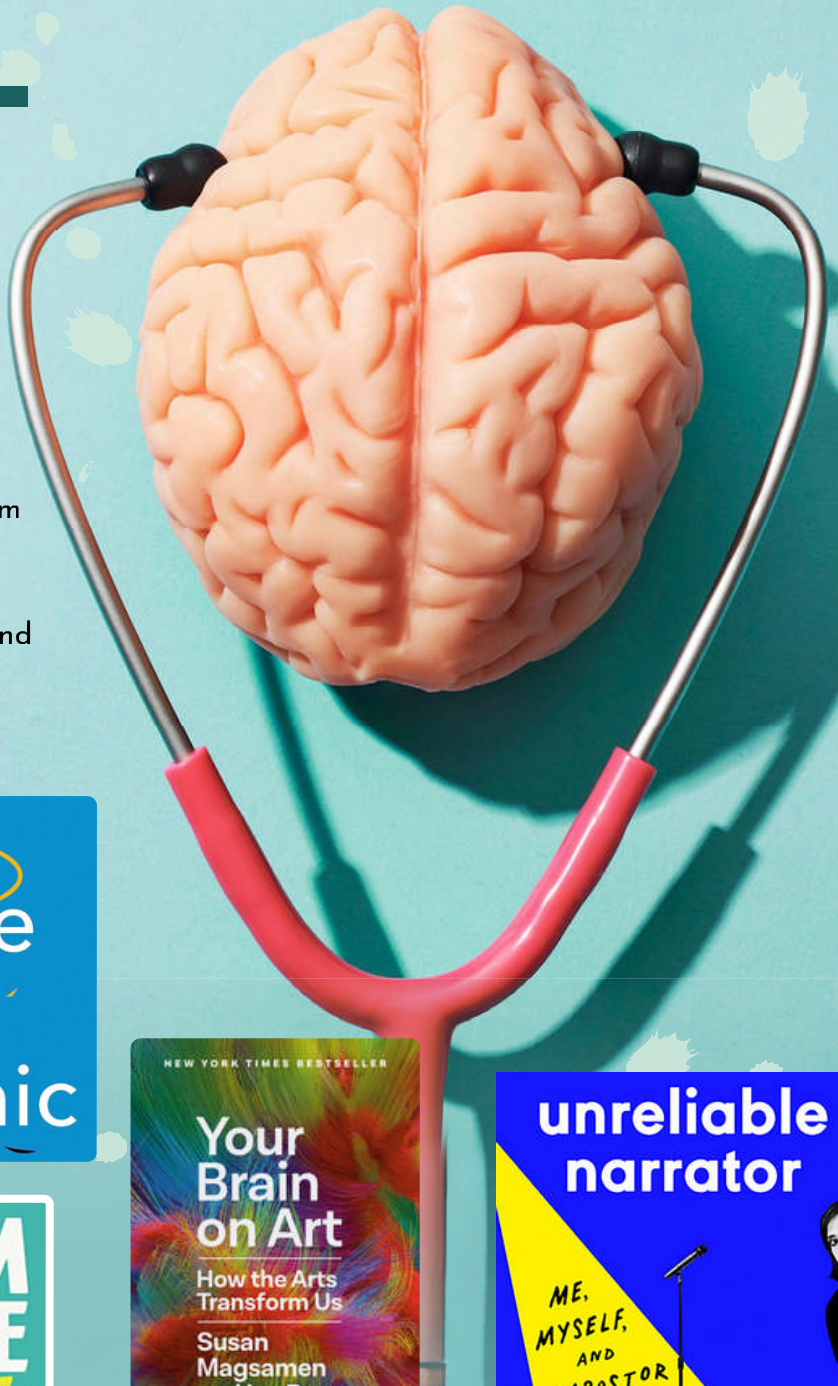

May is Mental Health Awareness Month. From imposter syndrome to rage, panic attacks, depression, and eating disorders - mental health encompasses a myriad of symptoms and causes. These books take on a number of the things bothering us in the 21st century.

Nonfiction

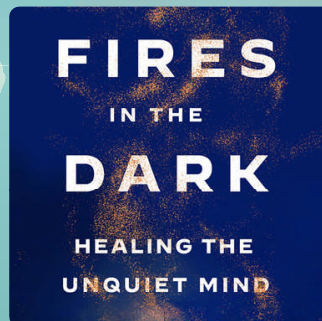
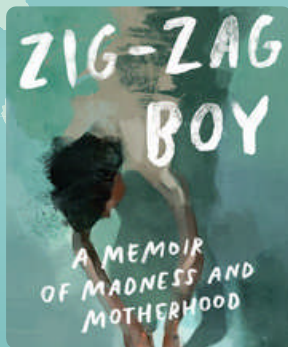
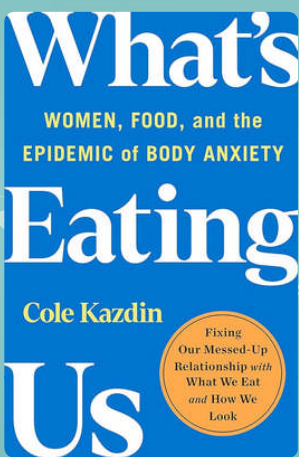
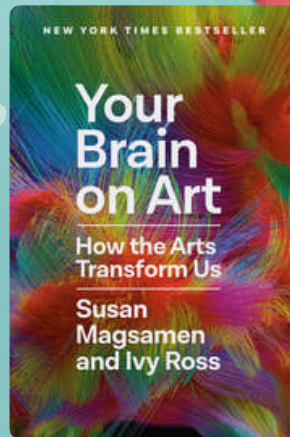
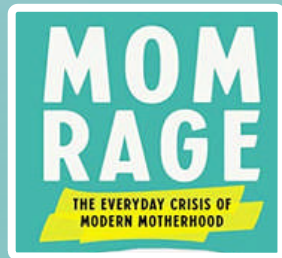
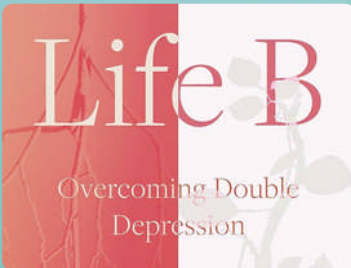
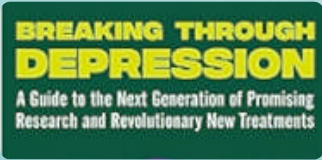

MENTAL HEALTH

Awareness

Youth Titles

Find books chosen in collaboration with the County of Ventura Employee Assistance Program (EAP) on a variety of mental health topics at [Cloud Library](#).

Children's Picturebooks

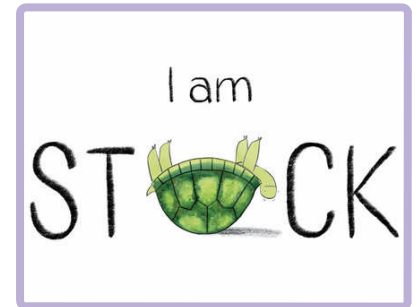

Children's Nonfiction

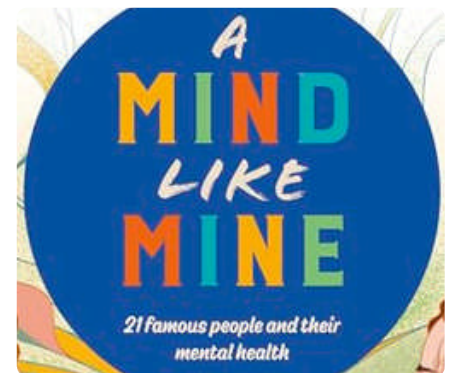
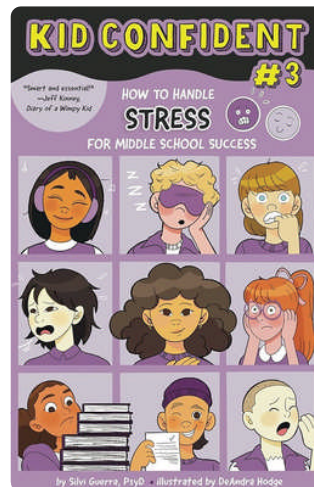

Young Adult

Fiction

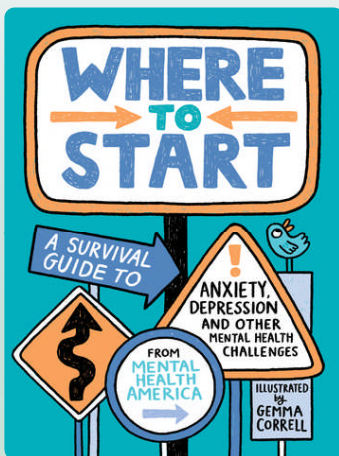

Nonfiction

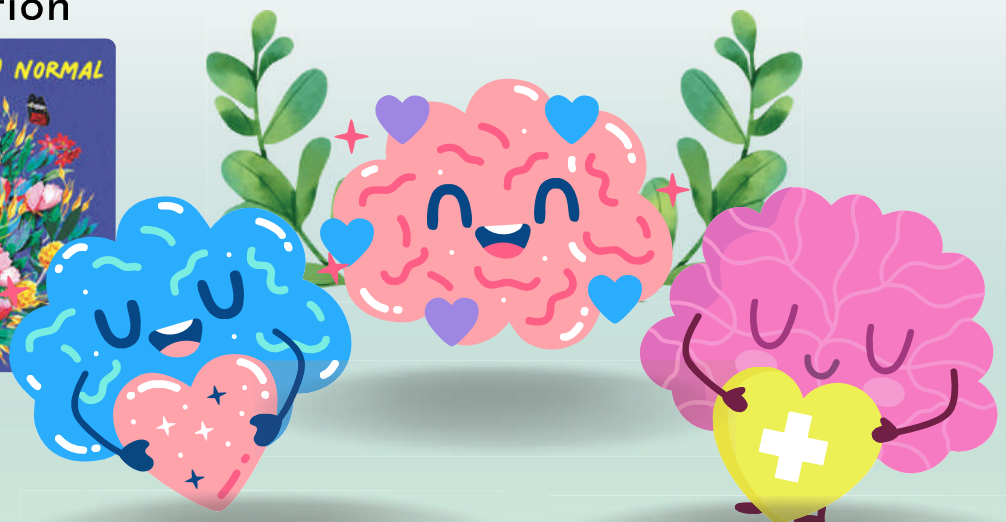
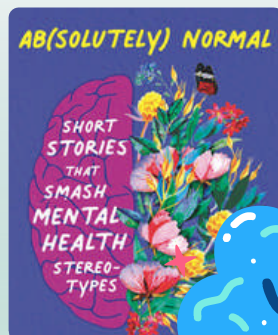

Gardens

Nonfiction

These books all feature gardens in some way or another. Delve into them and take time to cultivate your attachment to the earth.

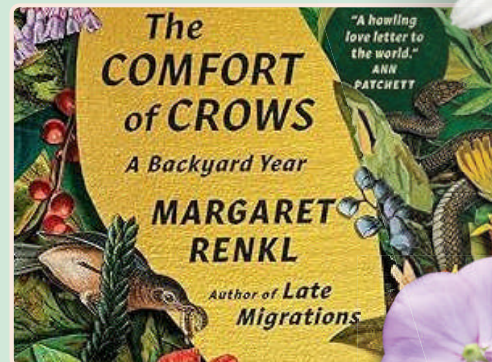
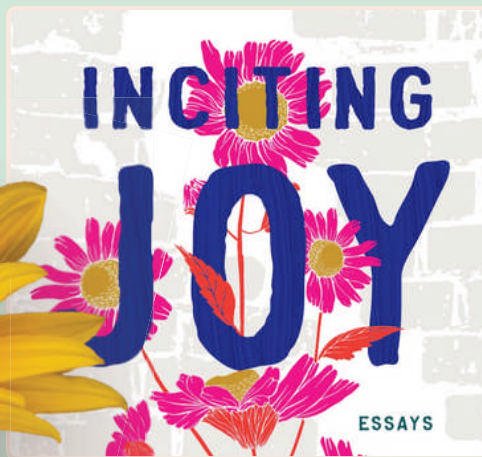
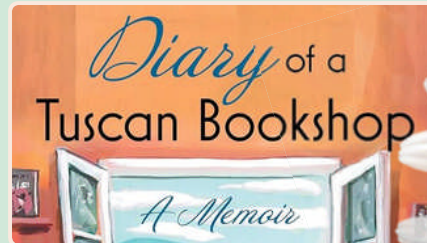

Ireland

Travel to Ireland via books this spring!



Fiction

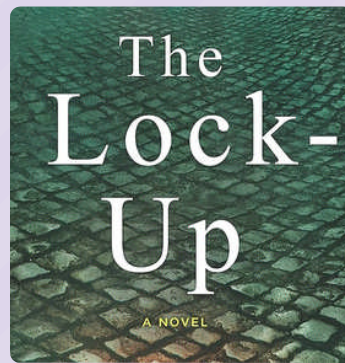
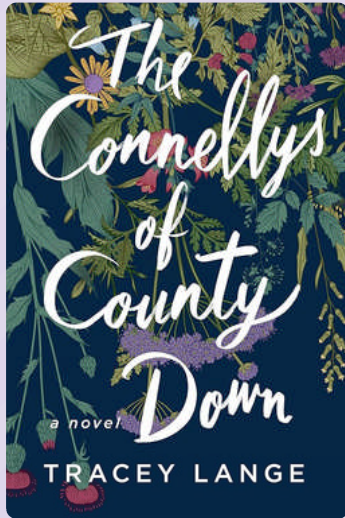

Nonfiction

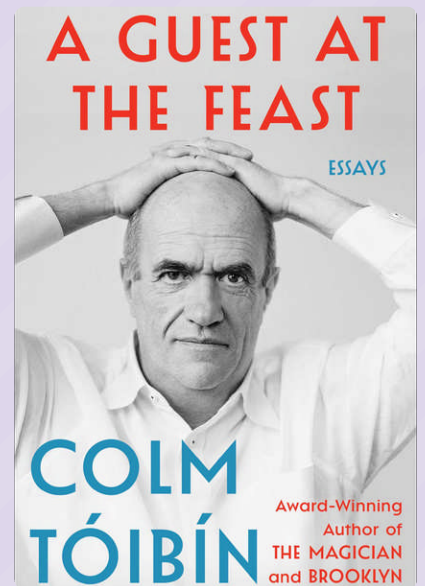
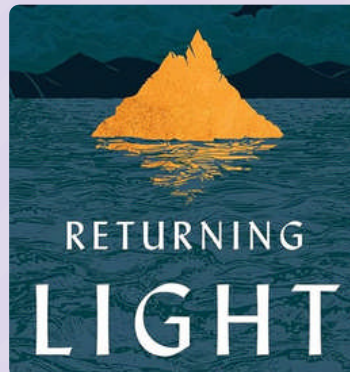
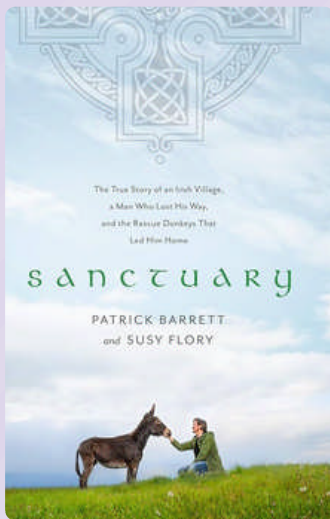



MAKE A JEEPNEY!

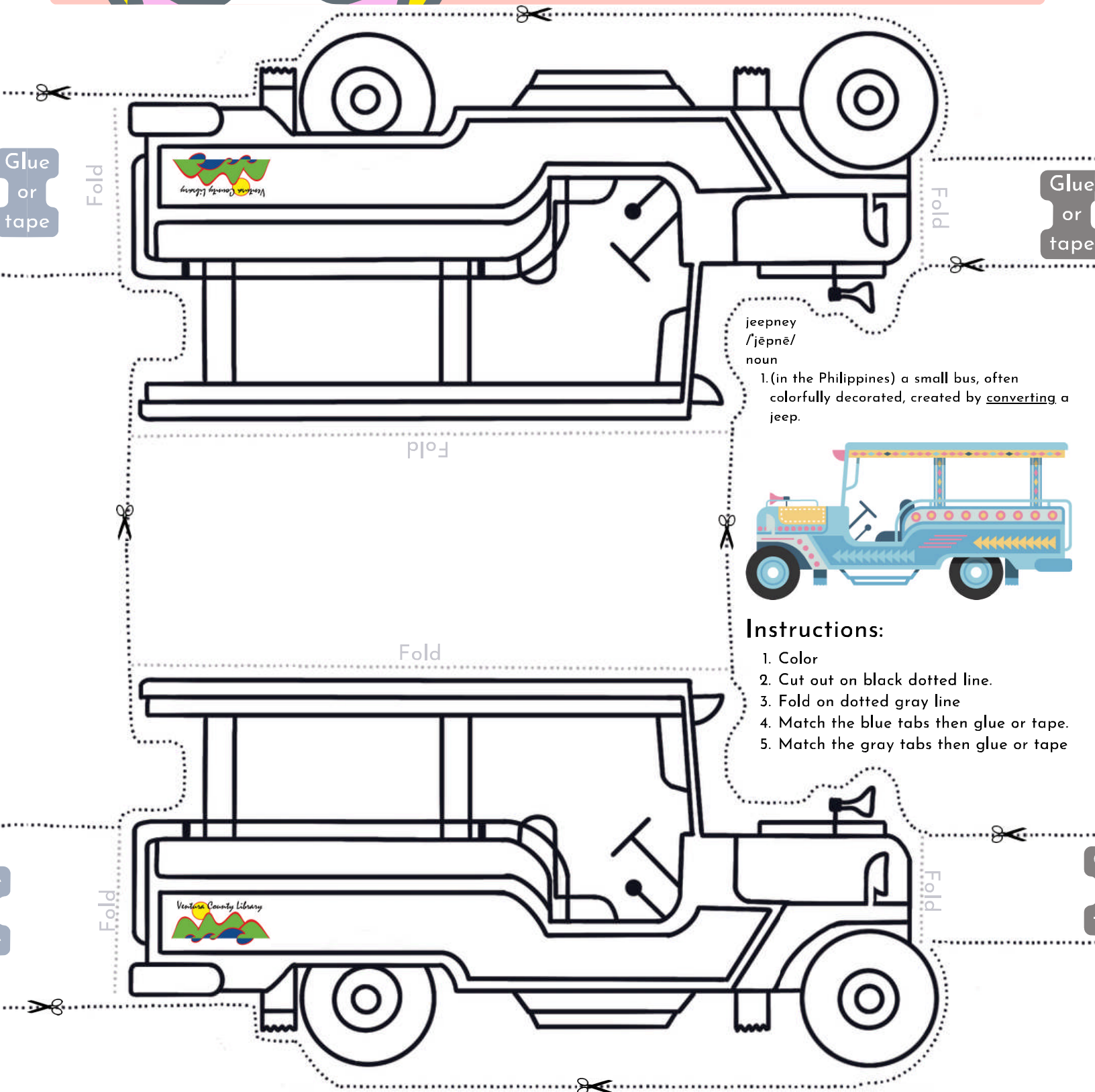

Glue or tape

Glue or tape

jeepney
/ˈjēpnē/
noun

1. (in the Philippines) a small bus, often colorfully decorated, created by converting a jeep.



Instructions:

1. Color
2. Cut out on black dotted line.
3. Fold on dotted gray line
4. Match the blue tabs then glue or tape.
5. Match the gray tabs then glue or tape



MAKE A TUK-TUK!

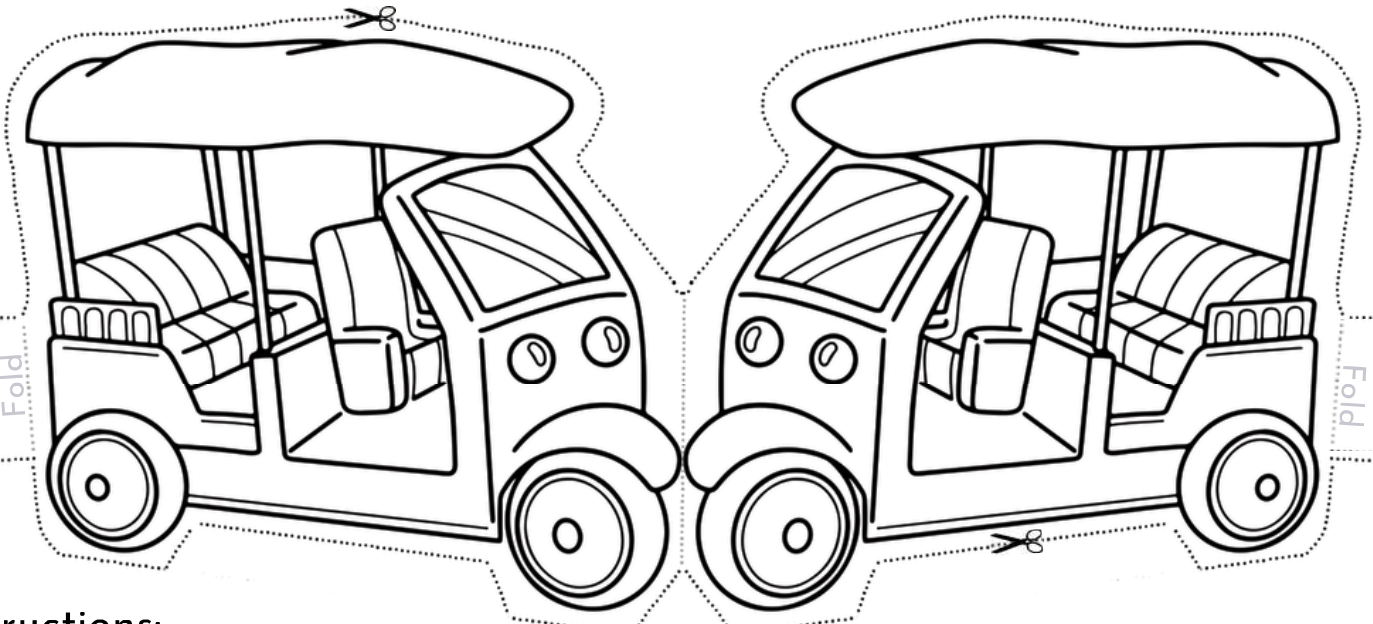

Instructions:

1. Color
2. Cut out on black dotted line.
3. Fold on dotted gray line
4. Match the blue tabs then glue or tape.



tuk-tuk
/ˈtʊktʊk/
noun

1. A motorized rickshaw, especially Southeast Asia or India.

